



THERA-TRAINER CORO USER MANUAL

EN English translation of original user manual



Congratulations!

Opting for a THERA-Trainer was a great choice. This innovative movement exerciser offers top performance „Made in Germany“.

This user manual will help you get to know your THERA-Trainer better. It will safely guide you through all functions and control options and provide you with tips and information on how to use your new exerciser best.

Before starting the unit for the first time, please read and observe chapter 2 “Safety and dangers”.

Should you have any questions or suggestions, your local specialist dealer will be happy to help.

Have fun and get moving with your THERA-Trainer.

1	USER GUIDE	4
1.1	Warning notices	4
1.2	Notes	4
1.3	Symbols in the user manual	4
1.4	Symbols on the product	5
2	SAFETY AND DANGERS	6
3	INTENDED USE	7
3.1	Indications	7
3.2	Biocompatibility	7
4	FORESEEABLE MISUSE	8
4.1	Contraindications	8
4.2	Misuse	8
5	SCOPE OF DELIVERY AND DESCRIPTION OF DELIVERED EQUIPMENT	9
5.1	Scope of delivery	9
5.2	Basic equipment	9
5.3	Options	9
6	OVERVIEW	10
7	START-UP	11
7.1	Unpacking	11
7.2	Installation of THERA-Trainer coro	11
7.3	Transport of THERA-Trainer coro	11
8	OPERATION	12
8.1	Preparation for training	12
8.2	Lifting the user into training position	17
8.3	Starting up the control and display unit	17
9	CLEANING AND DISINFECTION	19
10	MAINTENANCE AND REPAIR	19
10.1	Replacing the balance unit	19
10.2	Replacing the pelvic safety strap	19
10.3	Further use	19
11	TECHNICAL DATA	20
12	STANDARDS AND LAWS	20
13	DISPOSAL	21
14	WARRANTY	21

1 USER GUIDE

User manual and product are labelled with symbols. The symbols and their functions make it easier to use the product safely and efficiently.

1.1 Warning notices

Classification of warning notices

There are different types of warning notices indicated by the following signal words depending on the type of danger:

- Caution** warns about the risk of material damage.
- Warning** warns about the risk of physical injury.
- Danger** warns about the risk of fatal injury.

Structure of warning notices

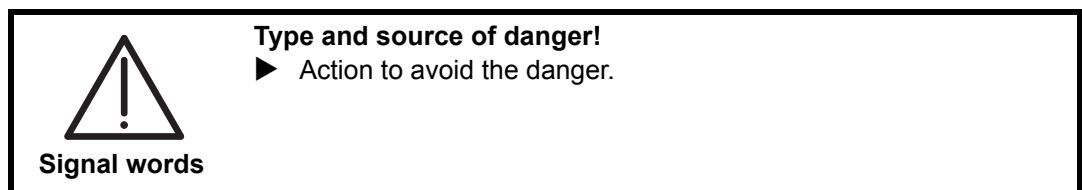

1.2 Notes

Note

Information on the efficient use of the product.

1.3 Symbols in the user manual

Instructions

Structure of instructions:

- ▶ Instruction to do something.

Result of the action, if necessary.

Lists











Structure of bulleted lists:

- List level 1
 - List level 2

Structure of numbered lists:

1. List level 1
2. List level 1
 - 2.1 List level 2
 - 2.2 List level 2

1.4 Symbols on the product

	User manual
	Observe the user manual!
	Manufacturer
	Date of manufacture
	Market launch according to directive 93/42 EEC for medical devices
	Serial number
	Type BF medical device
	Disposal Do not dispose of product with the regular household waste. Dispose of product in accordance with local regulations.
	Protect product from humidity.
	Maximum body weight

2 SAFETY AND DANGERS

- ▶ Observe the user manual.
- ▶ Use THERA-Trainer coro exclusively in good and functional condition.
- ▶ Regularly check tightness of screws.
- ▶ Prior to the initial start-up, have your specialist dealer, doctor or therapist show you how to use the product.
- ▶ Put THERA-Trainer coro on even and slip-proof floor.
- ▶ Keep sufficient distance between THERA-Trainer coro and any walls and obstacles.
- ▶ Always wear closed shoes when training (both user and assistant).
- ▶ Always use THERA-Trainer coro with pelvic safety strap.
- ▶ Before every training, make sure that pelvic safety strap is correctly buckled.
- ▶ Before getting in, make sure that all transport castors with brake are blocked.
- ▶ Block balance function before getting in.
- ▶ Exercise exclusively under supervision of a trained assistant.
- ▶ Do not use THERA-Trainer coro in wet, humid or hot environments.
- ▶ Have exclusively trained dealers do any repair or maintenance work.
- ▶ In case of damage, malfunctions, etc. of the THERA-Trainer coro, contact a trained dealer immediately.
- ▶ Consult the manufacturer before any modification and modify THERA-Trainer coro exclusively with the manufacturer's approval.
- ▶ Disinfect THERA-Trainer coro before every training.
- ▶ Do not smoke while exercising.
- ▶ Make sure that THERA-Trainer coro does not get wet.
- ▶ Do not use THERA-Trainer coro to transport persons.
- ▶ If any symptoms of illness occur during or after training, seek medical advice immediately.
- ▶ Make sure that buckle tongues audibly click into place in belt buckles.
- ▶ When laying cables, make sure that
 - the user's movements are not limited.
 - the movements of the THERA-Trainer coro are not limited.
 - there is no risk of persons falling over or being limited by cables.
- ▶ Use the manufacturer's original parts exclusively.
- ▶ Use control and display unit exclusively with undamaged and functional cables.
- ▶ Take care not to pinch any fingers when adjusting settings (e.g. upper pipe frame) on THERA-Trainer coro.
- ▶ Before using the THERA-Trainer coro, check if knee support simple is fastened correctly.
- ▶ Before every training, make sure that safety equipment is working correctly.
- ▶ Before every training, make sure that balance unit is working correctly.
- ▶ Keep animals and playing children away from THERA-Trainer coro.
- ▶ Set spring resistance of THERA-Trainer coro to fit the user's activity, body size and body weight.

3 INTENDED USE

The THERA-Trainer coro is an indoor therapy device for supervised indoor use only.

The THERA-Trainer coro helps the user to stand dynamically or maintain a vertical (or nearly vertical) position by:

- Verticalisation
- Tone regulation
- Improving balance (with fall prophylaxis).
- Maintaining or prolonging the supporting leg phase.
- Preventing muscular atrophy.
- Strengthening existing musculature.
- Stabilising the hip joint.
- Improving upper body stability.
- Activating or stabilising the circulation.
- Activating or stabilising the metabolism.

The THERA-Trainer coro is a medical device. The intended use includes the treatment as a medical device. **Note**

3.1 Indications

The THERA-Trainer coro is suitable for users with congenital or acquired restrictions or loss of their ability to stand (e.g. for stroke patients, elderly patients, or persons with multiple sclerosis, Parkinson's disease, muscular diseases or paraplegia).

The THERA-Trainer coro is suitable for users with balance or coordination problems while standing.

Minimum requirement:

- the user's lower extremities are able to support his full weight.

To stand in the THERA-Trainer coro without assistance:

- The user is able to stand and actively straighten their upper body.

If the user is able to control the THERA-Trainer coro without assistance:

- Make sure that a trained assistant supervises the training.

3.2 Biocompatibility

All components and options of the THERA-Trainer coro the user will touch when using the unit as intended are designed to meet the biocompatibility requirements of the applicable standards.

- ▶ For any questions, contact a trained dealer.

4 FORESEEABLE MISUSE

The THERA-Trainer coro is not suitable for:

- Diagnosis
- Monitoring
- Measuring

4.1 Contraindications

Do not use THERA-Trainer coro for:

- users weighing more than 140 kg.
- users shorter than 135 cm.
- users taller than 200 cm.
- users with serious contractures.
- users with ulcers or raw skin that would touch the unit (if in doubt, seek medical advice).
- users with extreme osteoporosis.
- users with imperfect osteogenesis (Osteogenesis imperfecta).
- users with unstable circulation,
 - e. g. due to being bedridden.
- users with limited exercise tolerance of their lower extremities.
- outdoor exercise.
- transport (e. g. of the user).
- unsupervised training.

4.2 Misuse

Do not use THERA-Trainer coro in:

- combination with other products emitting ionising radiation (e. g. radiation therapy, nuclear medicine, etc.)
- rooms containing
 - explosive substances
 - oxygenated air
- the presence of
 - flammable anaesthetics
 - volatile solvents

5 SCOPE OF DELIVERY AND DESCRIPTION OF DELIVERED EQUIPMENT

The THERA-Trainer coro comes with individual options. This user manual describes all options available for the THERA-Trainer coro. Depending on the model, the user manual may include options not featured by the THERA-Trainer coro. If the THERA-Trainer coro features options not described in the user manual, an appendix will be included.

5.1 Scope of delivery

The delivery note contains all necessary information on the scope of delivery.

5.2 Basic equipment

Basic equipment of THERA-Trainer coro:

- Base unit
 - Powder-coated metal frame
 - Transport castors with brake (blockable)
- Tread unit
 - Wear-resistant anti-slip mat
- Balance unit
- Knee support simple
- Pelvic safety strap
- Hand/arm fixing
 - Stay tubes (adjustable)
 - Upper pipe frame
- User manual THERA-Trainer coro

5.3 Options

Available options:

- Tread extension
- Cushion for arm rest
- Control and display unit with 23" colour screen incl. touch function, in combination with:
 - Mobile holder for control and display unit
- Control and display unit with 10.4" colour screen incl. touch function, in combination with:
 - Table holder for control and display unit
- Software package Balancing individual therapy
- Position sensor

6 OVERVIEW

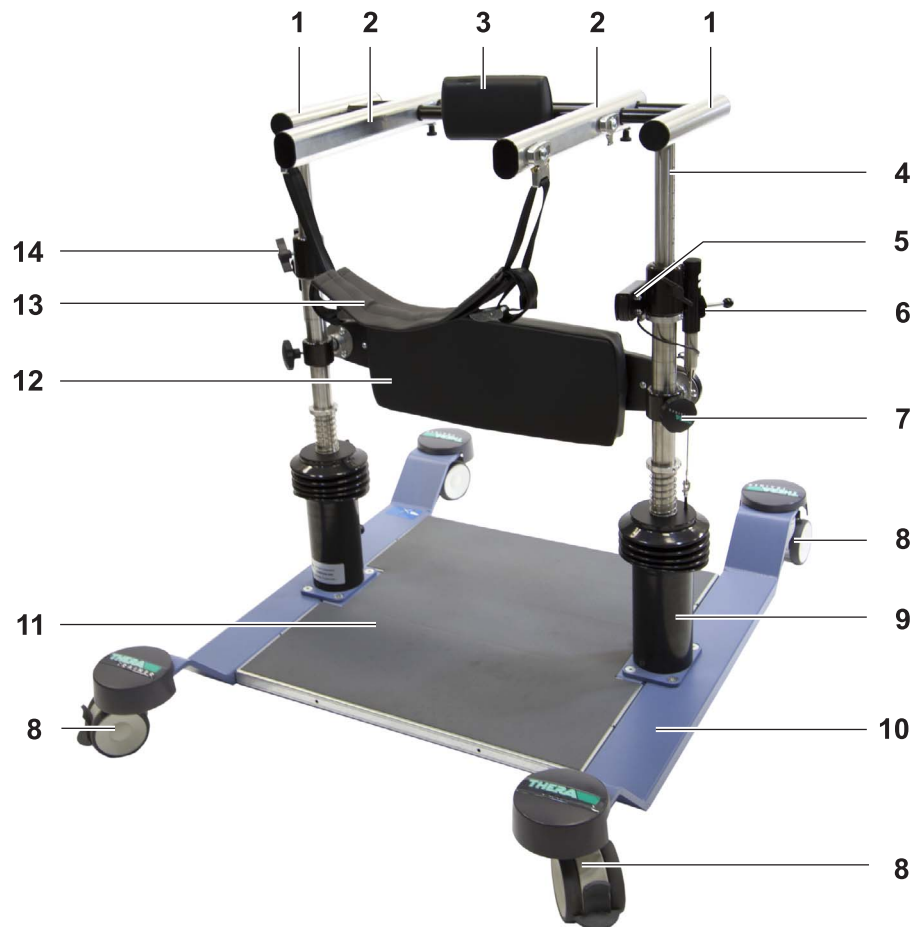

- (1) Upper pipe frame
- (2) Stay tube
- (3) Stomach cushion
- (4) Vertical pipe of balance unit
- (5) Position sensor
- (6) Release lever for balance function
- (7) Height adjustment of simple knee support
- (8) Transport castors with brake
- (9) Balance unit with settings for spring resistance
- (10) Base unit
- (11) Tread unit
- (12) Knee support simple
- (13) Pelvic safety strap
- (14) Height adjustment of upper pipe frame

7 START-UP

7.1 Unpacking

Unpack THERA-Trainer coro:

- ▶ Remove THERA-Trainer coro from packaging.
- ▶ Check THERA-Trainer coro incl. all accessories/options for transport damage.
- ▶ Check if delivery is complete.
- ▶ Inform supplier or forwarding agent immediately about any damage.
- ▶ Check if supply voltage of control and display unit matches voltage supply.

7.2 Installation of THERA-Trainer coro

Connecting the position sensor



Caution

Material damage due to incorrect installation!

- ▶ Make sure that USB cable is correctly plugged in.

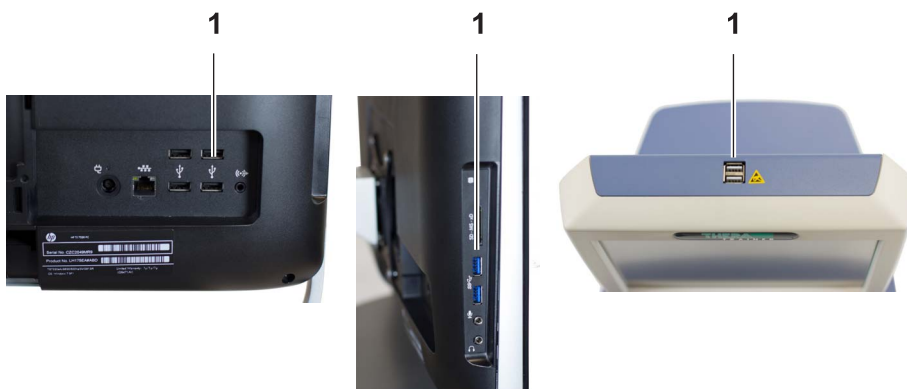

- ▶ Plug USB cable of position sensor into USB interface 1 of control and display unit.
- ▶ The USB interfaces are located on rear, side or top of the control and display unit.
- ▶ Observe the enclosed user manual.

7.3 Transport of THERA-Trainer coro



Warning

Risk of injury due to incorrect transport!

- ▶ Do not use THERA-Trainer coro for training in transport condition.
- ▶ Never use THERA-Trainer coro to transport users.

- ▶ Use exclusively transport castors with brake for moving the THERA-Trainer coro.
- ▶ Before any transport, make sure that
 - THERA-Trainer coro is standing on transport castors with brake.
 - balance function is locked.

8 OPERATION

8.1 Preparation for training



Warning

Risk of injury due to insufficient preparation!

- ▶ Before starting any exercise, make sure that balance unit is intact and working correctly.
- ▶ Make sure that pelvic safety strap is not damaged (e. g. intact seams).
- ▶ Make sure that pelvic safety strap is correctly positioned and safely attached to buckles.
- ▶ Disinfect THERA-Trainer coro before every training (see 9 Cleaning and disinfection).

Note

Markings on upper pipe frame and knee support simple simplify horizontal adjustment.

Before every training session, adjust settings of THERA-Trainer coro to match the user's individual needs.

Locking transport castors with brake

Prevent THERA-Trainer coro from moving as follows:

- ▶ Before every training session, lock all four transport castors with brake.
- ▶ Push down locking lever on transport castors with brake.

Releasing transport castors with brake

To transport THERA-Trainer coro:

- ▶ Release locking lever on transport castors with brake.

Setting the height of the upper pipe frame

Note

A pneumatic spring supports the height adjustment.

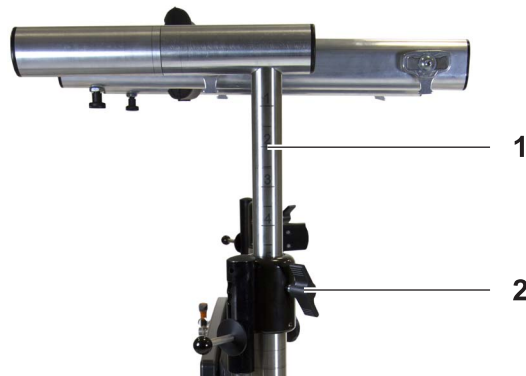

- ▶ Release winged screw **2** on first vertical pipe.
- ▶ Set height using marks **1**.
- ▶ Tighten winged screw on vertical pipe.
- ▶ Set height on second vertical pipe.
- ▶ Make sure that height settings of left and right vertical pipe of table unit are the same.

Adjusting the broad stay tubes



- ▶ Pull out safety catches **1** of stay tube.
- ▶ Adjust stay tubes to fit the width of the user's pelvis.
- ▶ Release safety catch.
- ▶ Make sure that safety catch audibly clicks into place.
- ▶ Make sure that settings of left and right stay tube are the same.

Adjusting the simple knee support



Warning

Risk of injury due to incorrectly adapted simple knee support!

- ▶ Prior to every training session, adapt simple knee support to the user's individual needs.
- ▶ Adjust simple knee support so as to prevent overextension of joints and damage to muscles, tendons or ligaments.

The simple knee support provides safe support for the user when rising and standing or during balance training. Adjusting the simple knee support does not require any tools.

In order to be able to lower the user quickly, put a chair or wheelchair directly behind the THERA-Trainer coro during the training session.

Note

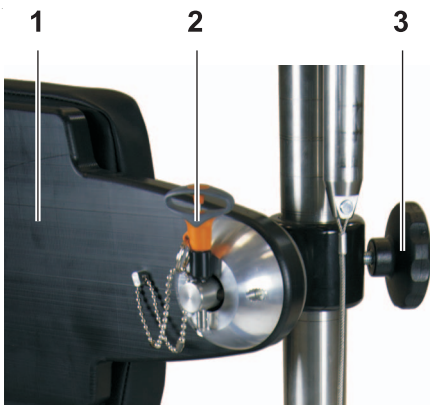

Setting the height:

- ▶ Loosen star-shaped handle **3** on first vertical pipe.
- ▶ Set height using marks.
- ▶ Tighten star-shaped handle on vertical pipe.
- ▶ Set height on second vertical pipe.
- ▶ Make sure that height settings of left and right vertical pipe are the same.

Removing the simple knee support:

- ▶ Remove simple knee support **1** before the user is standing in THERA-Trainer coro.
- ▶ Pull ball catch pin **2** out of securing system.
- ▶ Pull knee support out of securing system.
- ▶ Make sure that user is able to maintain upright standing position safely and without assistance.

Putting on the pelvic safety strap

Note

Use THERA-Trainer coro exclusively with pelvic support strap.

The pelvic support strap safely supports the user's pelvis in the back.

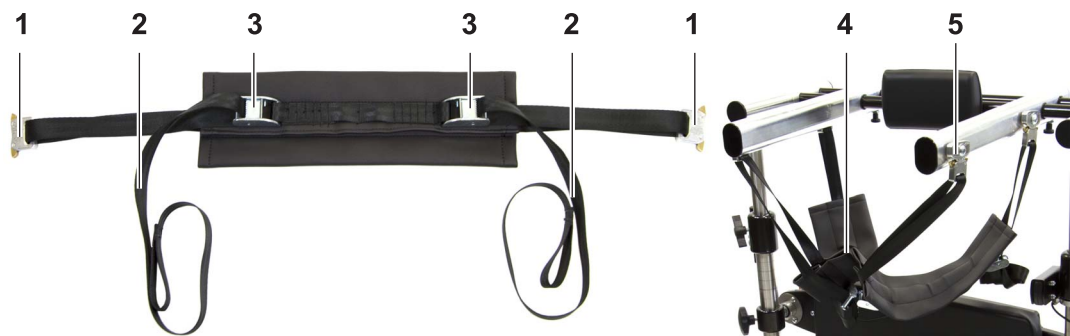

- ▶ Position the user in an optimal training position.
- ▶ Attach belt buckles **1** in securing system **5** on stay tubes.
 - Select the same position for left and right side.
- ▶ Make sure that buckle tongues audibly click into place in belt buckles.
- ▶ Make sure that pelvic safety strap runs below stay tubes.
- ▶ Shorten pelvic safety strap by pulling on shackles **2**.
- ▶ If necessary, lengthen pelvic safety strap by opening clamping locks **3**.
- ▶ With a second pelvic safety strap, it is possible to stabilise the user in a pelvic harness **4**.

Positioning arm support cushions



- ▶ If required, put arm support cushion for paretic arm on upper pipe frame and secure with Velcro straps.
- ▶ Clean and disinfect arm support cushion if necessary.

Installing the tread extension

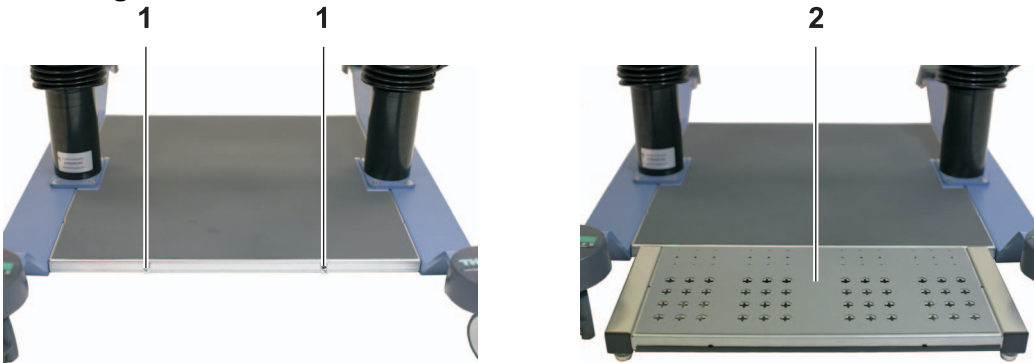

- ▶ Hook tread extension **2** into screws **1**.

Transporting the THERA-Trainer coro when the tread extension is installed is not possible. **Note**

- ▶ Transport THERA-Trainer coro exclusively without tread extension.

Setting balance function



Before every training session:

- ▶ Lift THERA-Trainer coro by upper pipe frame on left and right side.

If it is possible to remove the vertical pipe from the balance unit, then training with the THERA-Trainer coro is not allowed.

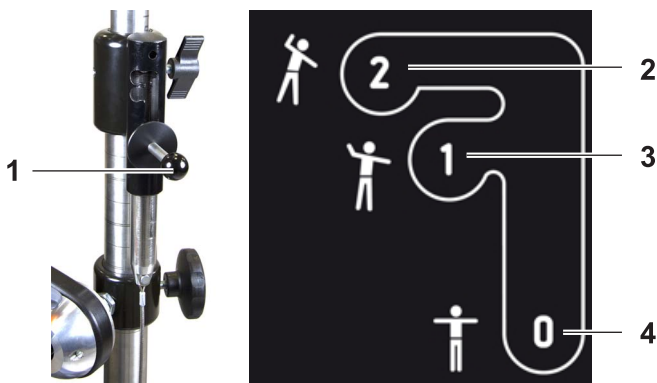
- ▶ Contact a trained dealer.



- ▶ Set release lever **1** to 0, 1 or 2 on both vertical pipes.
 - Position 0  = balance function disabled **4**.
 - Position 1  = balance function enabled with limited range of movement (up to 6°) **3**.
 - Position 2  = balance function enabled with full range of movement (up to 11°) **2**.
- ▶ Make sure that release lever latches in.
- ▶ Set balance function to the same position on both sides.

Spring resistance settings**Warning****Risk of injury due to tipping over!**

- ▶ Set spring resistance to fit the user's activity, body size and body weight.

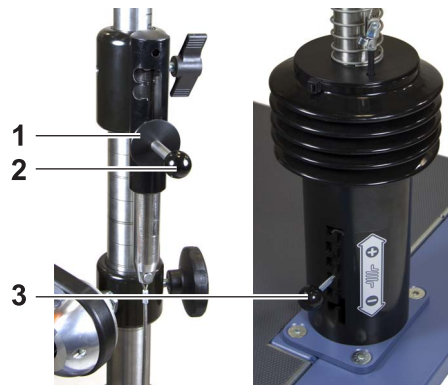

- ▶ Set release lever **2** to 0 (**1**).
- ▶ Use lever **3** on balance unit to set spring resistance.
 - Down = low spring resistance
 - Up = high spring resistance
- ▶ Make sure that release lever latches.
- ▶ Make sure that spring resistance is the same on left and right balance unit.

8.2 Lifting the user into training position



Warning

Danger of injury due to not using a chair/wheelchair!

When lifting up or sitting the user down:

- ▶ Always position chair/wheelchair directly behind user.
- ▶ Lock brakes of wheelchair.

if necessary, lift or lower the user with the help of an assistant who is trained for the process.

Note

To lift the user:

- ▶ Set height (see 8.1 Preparation for training)
 - of simple knee support
 - of upper pipe frame
- ▶ Before starting the training session, make sure that transport castors with brake are locked.
- ▶ Move user directly behind THERA-Trainer coro in a wheelchair.
- ▶ Secure wheelchair to prevent it from moving.
- ▶ Put the user's feet on the tread of THERA-Trainer coro.
- ▶ Put knees on simple knee support.
- ▶ Lift the user and stand him into the training position.
- ▶ Apply pelvic safety strap and secure the user with belt buckles (see 8.1 Preparation for training).

To lower the user:

- ▶ Move wheelchair directly behind THERA-Trainer coro.
- ▶ Remove pelvic safety strap from user.
- ▶ Seat user in chair or wheelchair.
- ▶ Remove the user's feet from the tread of THERA-Trainer coro.

8.3 Starting up the control and display unit

The control and display unit supports goal-oriented training with biofeedback illustrations.

Note

Use control and display unit with 10.4" or 23" colour screen exclusively with software package Balancing individual therapy, position sensor and holder.

- ▶ Switch on control and display unit.
- ▶ Operate control and display unit via touch soft keys.
- ▶ Observe the enclosed user manual.

Adjusting the mobile holder

Mobile holder is suitable for control and display unit with 23" colour screen.

- ▶ Set mobile holder individually to
 - correct height.
 - correct tilt.
 - correct distance.
- ▶ Before starting the training session, make sure that transport castors with brake are locked.
- ▶ Observe the enclosed user manual.

Adjusting the table holder

Note

Table holder is suitable for control and display unit with 10.4" colour screen.

- ▶ Set table holder individually to correct tilt.
- ▶ Before every training session, make sure that metal support foot is in optimal training position.
- ▶ Observe the enclosed user manual.

Setting the software package Balancing individual therapy

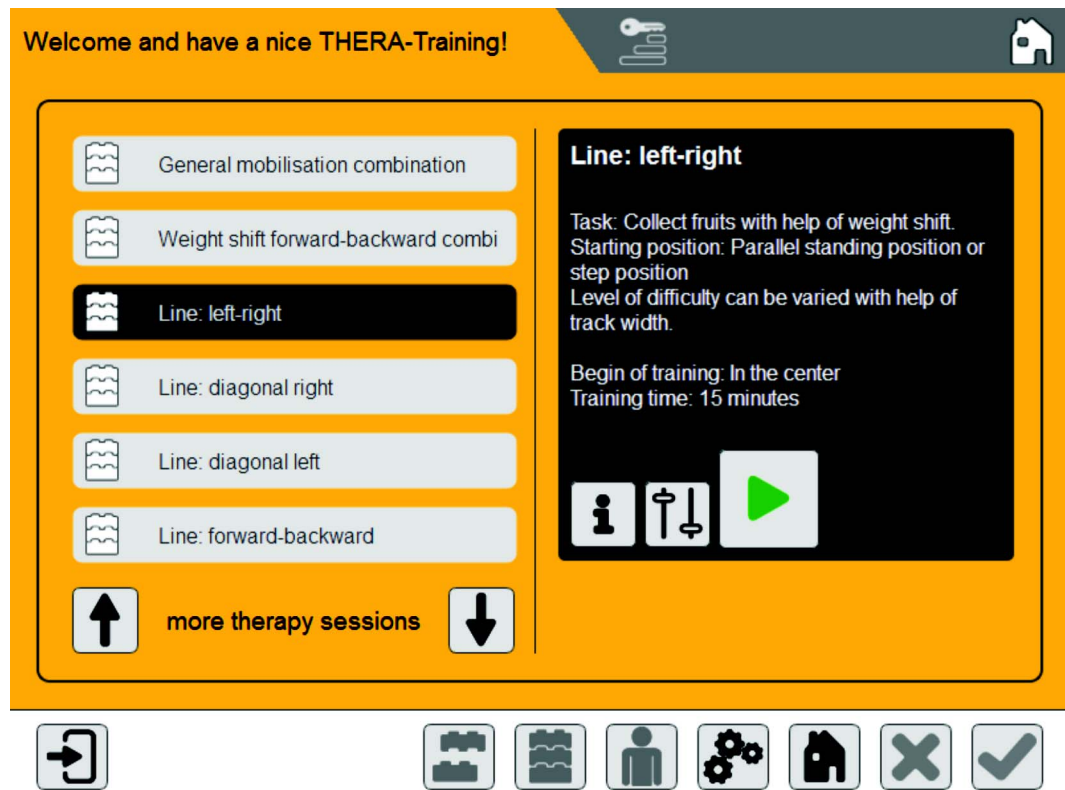

Functions:

- it is possible to choose between several therapy sessions/biofeedback illustrations
- quick start with 2 buttons is possible
- up to 5 training parameters per training session can be set (e.g. coordination, training time, etc.)
- It is also possible to configure one's own individual training sessions from pre-set modules.
- ▶ Observe the enclosed user manual.

9 CLEANING AND DISINFECTION



Warning

Risk of infection due to contaminated accessories/options!

- ▶ Wear gloves for cleaning and disinfection.



Caution

Material damage due to incorrect cleaning or disinfection!

- ▶ Never use cleaning agents that are aggressive, abrasive or caustic, or contain solvents.
- ▶ Never use cleaning agents that contain alcohol, cleaning solvent or ammonia.
- ▶ Use exclusively mild and environment-friendly cleaning agents and disinfectants.
- ▶ Use exclusively disinfectants that conform to country-specific regulations.
- ▶ Observe safety instructions by manufacturers of cleaning agents and disinfectants.

Clean/disinfect THERA-Trainer coro as follows:

- ▶ Clean surface of THERA-Trainer coro with a soft damp cloth.
- ▶ Clean foils and stickers with care.
- ▶ To clean surfaces of THERA-Trainer coro, use exclusively disinfectants approved in accordance with country-specific directives.
- ▶ Allow THERA-Trainer coro to dry.

10 MAINTENANCE AND REPAIR

10.1 Replacing the balance unit

According to the manufacturer's specifications, the balance unit of the THERA-Trainer coro must be replaced after five years. **Note**

10.2 Replacing the pelvic safety strap

According to the manufacturer's specifications, the pelvic safety strap of the THERA-Trainer coro must be replaced after five years. **Note**

10.3 Further use

The THERA-Trainer coro is suitable for further use by a different customer.

Before every further use of the THERA-Trainer coro

- ▶ Clean and disinfect thoroughly (see 9 Cleaning and disinfection).
- ▶ Replace all cushions, Velcro straps and the pelvic safety strap.
- ▶ Make sure that all accessories and options are at hand (see delivery note).
- ▶ Perform a safety inspection by way of a visual check or a functional check.
- ▶ Ask the manufacturer for the service instructions for safety control.

11 TECHNICAL DATA

THERA-Trainer coro	
Dimensions:	l x w x h 122 cm x 93 cm x 92 - 130 cm
Weight	77 - 81 kg (without control and display unit)
Power supply for control and display unit	230 V~, 50/60 Hz
Medical device class	I
Protection class: <input type="checkbox"/> THERA-Trainer coro	II
Degree of protection	Type BF
Protection category	IP2X
Sound emission	LpA < 45 dB(A)
Ambient conditions for use	5 °C to 40 °C 5% to 93% Rh 700 to 1,060 hPa
Ambient conditions for transport/delivery	-25 °C to 70 °C 5% to 93% Rh 700 to 1,060 hPa
Suitable for users with <input type="checkbox"/> Body height <input type="checkbox"/> Body weight	135 to 200 cm up to 140 kg
Materials used	steel, stainless steel, aluminium, rubber, plastics (POM, PA6, ABS, PE)
Economic life-time THERA-Trainer coro:	10 years

12 STANDARDS AND LAWS

The THERA-Trainer coro conforms to the following standards:

- MDD 93/42 EEC
- DIN EN ISO 13485
- Machinery directive 2006/42 EC
- DIN EN 12182

13 DISPOSAL

To dispose of the THERA-Trainer coro:

- ▶ Observe country-specific regulations and specifications.
- ▶ Dispose of metal parts as scrap metal.
- ▶ Dispose of plastic parts as prescribed, depending on the type of material.
- ▶ Dispose of electric and electronic components as electronic scrap.

14 WARRANTY

In accordance with legal regulations, the manufacturer grants a manufacturer's warranty for the THERA-Trainer coro if it is handled with due care. The basis is the date of delivery.

Within this period of time, the manufacturer will replace free of charge any faulty parts of the THERA-Trainer coro or repair free of charge the THERA-Trainer coro in the factory or an authorised workshop.

Excluded from manufacturer's warranty:

- Wear parts
- Opened devices
- Unauthorised accessories or external devices
- Devices repaired by persons other than trained dealers.
- Any damage due to incorrect use.

NOTES

MANUFACTURER:

THERA-Trainer®

a trademark of
medica Medizintechnik GmbH

Blumenweg 8
88454 Hochdorf
Germany

Phone: +49 7355-93 14-0
Fax: +49 7355-93 14-15

E-mail: info@thera-trainer.de
Internet: www.thera-trainer.de

Base unit: A002-307
Version: 04/2013

For declarations of conformity, see www.thera-trainer.de